

A guide to
install a new
bathroom

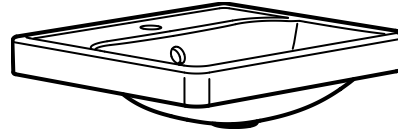

Bathroom installation guide

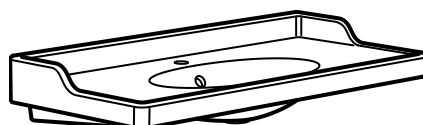
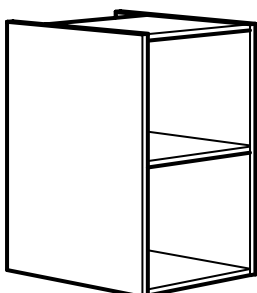
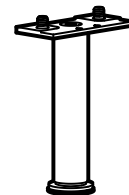
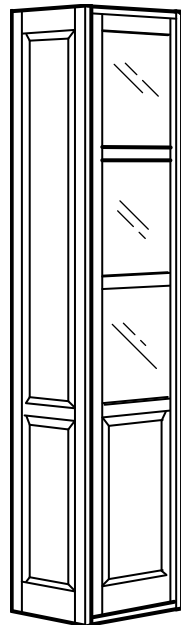
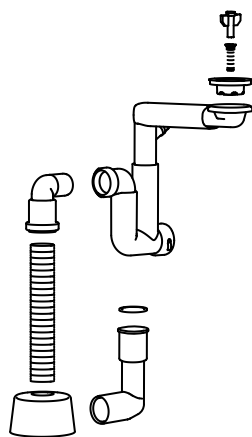
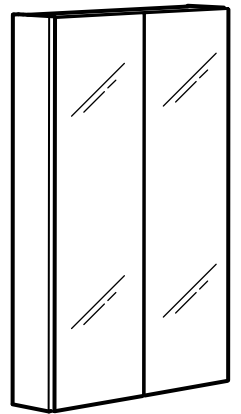
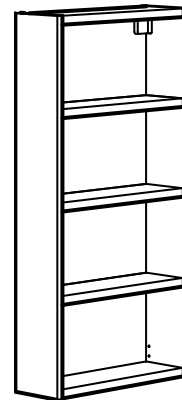
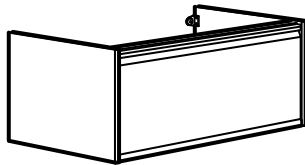
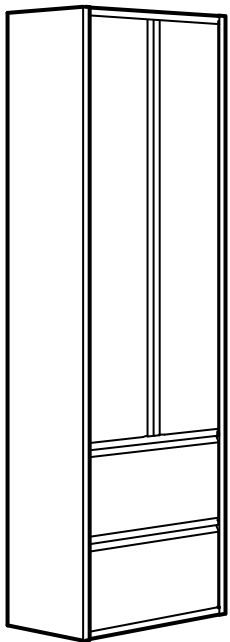

Step-by-step guide to installing your new bathroom

This brochure is your guide to preparing and installing your new bathroom yourself. Inside you'll find tips and ideas, clear steps to follow and the tools you'll need. Use this guide along with your assembly instructions to make sure your bathroom is installed in the correct way.

We're here if you need a hand

Our bathrooms are designed to be as simple as possible for you to assemble and install yourself, but some steps might be a bit more complex and require special skills. That is why we offer a wide range of services to assist you along the way. Maybe you just need a little help, or perhaps someone to do the whole job for you. We are happy to put together a service package that's just right for you. For more information about the services, visit our website at IKEA.CH or get in contact with your local IKEA store.

Before you begin

Before you get started, take a look at this brochure to see what stages are involved in putting in your new bathroom and organise what tools you'll need.

When you have received your new bathroom, make sure that it contains all parts. A good way to do this is to check the packages you have at home against the order list. You should only dismantle your old bathroom when you are certain that you have all your new furniture parts. Remove your old bathroom and make sure that the electricity and water supply are shut off before you begin.

Hire professionals

It's a good idea to contact qualified specialists early on to discuss the help you'll need with plumbing, tiling and electricity. If you need to modify the location of water or electricity supplies to suit your new bathroom, hire qualified specialists to do a safe and professional job. This will ensure that your home insurance will apply if anything goes wrong now or in the future.



Table of contents

Step-by-step guide to installing your new bathroom.....	02
Table of contents.....	03
Preparation is key for success.....	04
Tools and materials	05
Knowing your walls.....	06
Think before you drill	07
Check everything and start to assemble	08
Mounting the wash-stand to the wall	09
Installing your bathroom	10
Installing wash-basin, water trap and mixer tap	11
Installing your bathroom accessories.....	12
Drilling into tiles.....	13
Drill-free accessories for wall mount.....	14
Suction cup installation.....	14
Adhesive system installation.....	14
The finishing touches makes all difference.....	15
Services	16

Preparation is key for success

Removing your old bathroom

Turn off the electricity and water supply before you start. Then disconnect all lines to the wash-basin and disconnect appliances. Take care when working with electricity. If in doubt, call in a qualified electrician.

Removing old furniture

Wear safety gloves and goggles when removing the old bathroom furniture. Start with base cabinets and then move on to wall cabinets. If the base cabinet supports a wash-basin, you will need to begin with that. If it has been glued into place, you may need a crowbar to remove it. You can then remove drawers, doors and, lastly, the cabinet itself. Once this is removed it will be easier to remove the wall cabinets.

Responsible disposal

Contact your local authorities to find out how to dispose of your old bathroom in an environmentally friendly way.

Prepare the room

With the room empty, now is the time to prime walls, apply paint, change tiles and/or install new flooring. Keep in mind that new flooring is easier to install at this stage, but remember to protect the new floor surface until the bathroom is finished.

Before you install your new bathroom, make sure that the room is fully prepared for the installation – tiles, pipework and electrical outlets need to be in place according to your plan. You may require some professional assistance to make it safe and secure according to your local plumbing and electrical regulations.

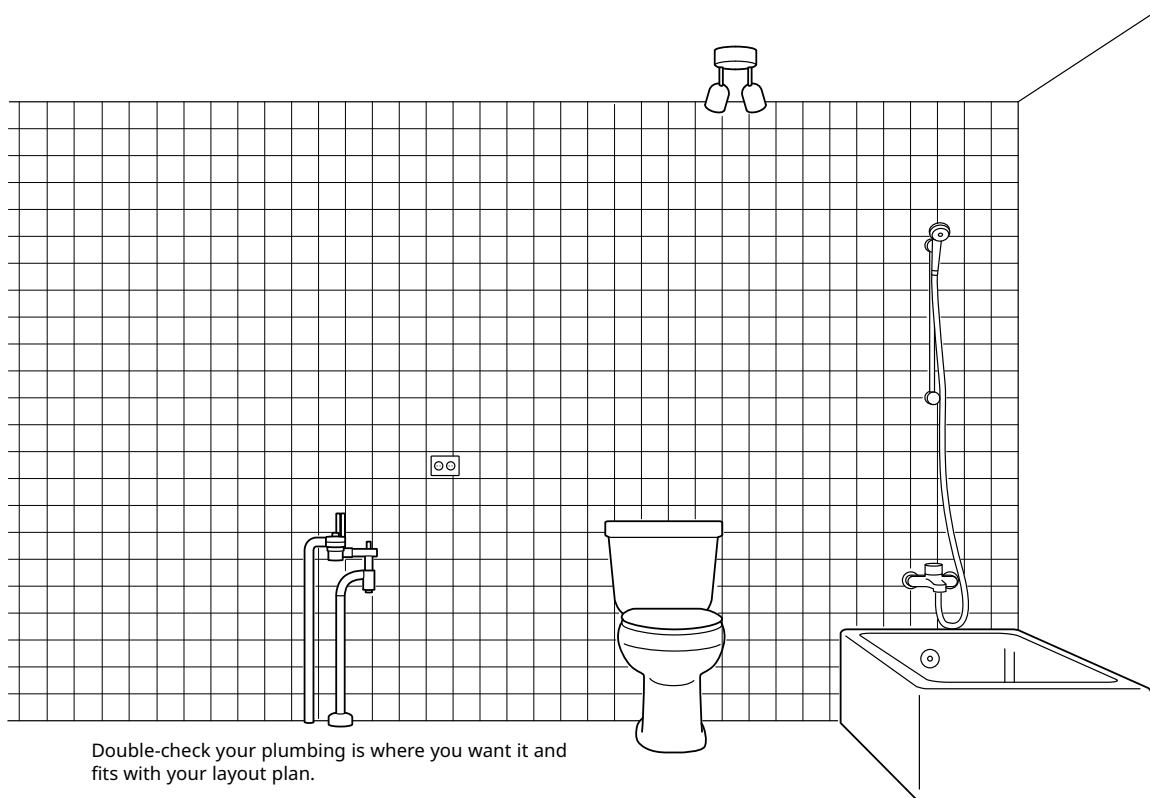

Tools and materials

Here are the tools and materials that you'll need. In addition you'll find what tools to use for each product in their respective assembly instruction.

Tools

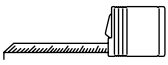

Carpenter's rule (or tape measure)

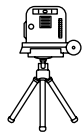

Cross line laser level

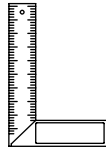

Try square



Spirit level

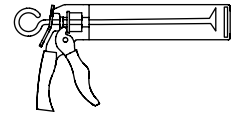

Tool for sanitary silicone sealant

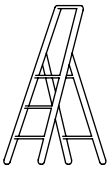

Step ladder



Stud finder



Pencil

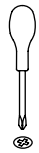

Screwdriver



Awl

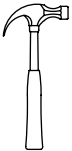

Hammer



Wrench



Knife

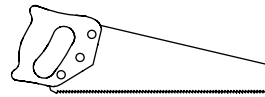

Saw



Protective gloves and goggles

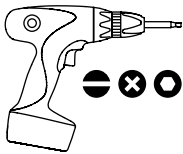

Electric screwdriver

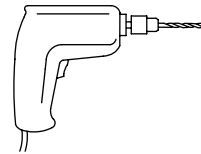

Electric drill

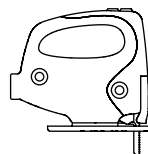

Jigsaw

Materials

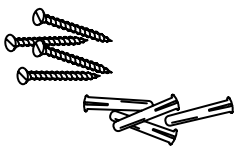

The right types of plugs and screws for your walls

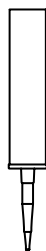

Sanitary silicone sealant



Masking tape, to be used when adding the silicone sealant

Knowing your walls

Before you start, you need to know what type of wall you have. There are many different types of walls. But basically, they all fall into one of two categories – stud walls and solid walls.

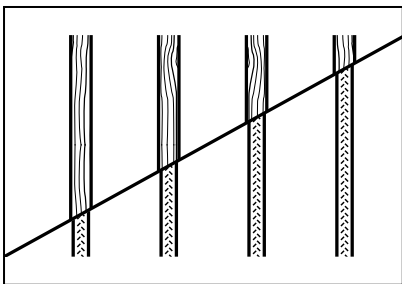

Stud walls

Built on a structure of vertical studs made of wood or metal. Always try to anchor at least one side of the furniture into a stud.

Drywall: The most common wall type. Made of sheets of gypsum that are easy to drill into.

Lath and plaster: A layer of plaster applied to a structure of wooden studs and laths. Common in US homes built before the 1950s.

Wood paneling: Decorative wood panels come in many shapes and styles.

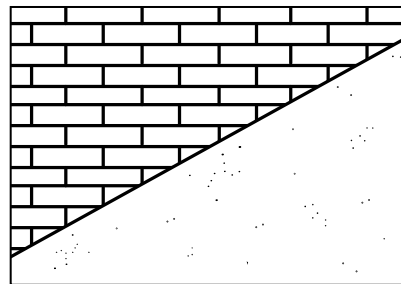

Solid walls

A bit tougher to drill into. But use a proper hammer drill with a masonry drill bit and you'll be fine.

Masonry: Bricks or stones bound together with mortar make up this classic wall type.

Concrete: As sturdy as they come – ranging from light-weight concrete to reinforced with steel bars. Made of blocks or complete wall sections.

Cinder block: A special type of concrete blocks with a cavity in the middle

Here are a couple of ways to find out what type of wall you have:

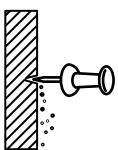

The push pin trick

If you can easily stick a push pin into the wall, it's most likely made of drywall. (You might also spot some white dust.)



The knock test

A stud wall often sounds hollow when you knock on it. A solid wall doesn't.

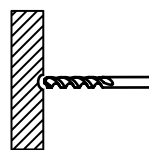

Drilling a hole

Drilling a small hole often can reveal a bit more about what's inside your wall. Try to find a hidden spot, and don't drill too deep.

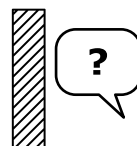

Just asking someone

Do you have a landlord or knowledgeable friend to ask? Great.

Think before you drill

This guide covers the most common wall types and practices. But homes are different, so if you're unsure in any way, please find someone to ask for help – such as a knowledgeable friend or a professional contractor.

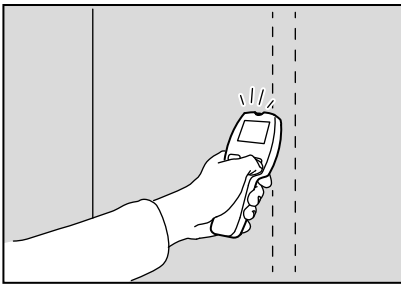

Check for wires and pipes

Drilling into wires or pipes could cause serious injury or property damage. Use a good quality wall scanner to scan the wall before you start drilling. This is especially important if you're drilling close to any power outlets, light switches or bathroom walls.

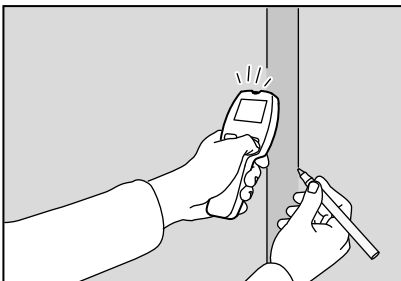

Stud wall: Locate studs

If you have a stud wall, use a stud finder, wall scanner or a strong magnet (for lath and plaster walls) to find a stud to attach to, and mark its edges with a pencil. Then position your piece of furniture or wall accessories so you can attach at least one of the screws into the middle of it.

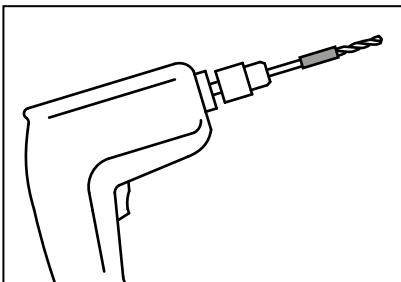

Tip: A piece of tape

Measure the drill bit against the plug and wrap a piece of coloured tape around it. This way, you'll know how deep you'll need the hole to be, and when to stop drilling.

Check everything and start to assemble

Work area and workflow

Now you are ready to start assembling your cabinets. But instead of rushing into things, prepare the area where you will assemble the cabinets and make sure you have a work area that is safe and big enough. Select an area that is flat, where you can place the cabinet parts. Also be sure to protect the floors.

Check all parts

Double-check to make sure you have all the parts for your bathroom. Sort the packages into groups to avoid confusion over which pieces belong to the cabinet assembly and which belong to the wash-basin, for example. Check again that you have all the required tools and the silicon sealant.

Use the right fixing hardware

Plaster, wood or concrete? Because there are many different types of walls, fixing hardware is not supplied with your furniture. Most hardware stores or home improvement stores stock appropriate fixing hardware and can help you choose the right kind for your walls.

Assembling the cabinets

For a good workflow, it is a good idea if you assemble all frames one by one and push them aside until it is time to install them.

Follow the assembly instruction that comes with each module and assemble all cabinet frames. Wait until later before fitting drawers, shelves and fronts.

It is important to secure that your bathroom walls can support the weight of the wash-stand. If you are uncertain about the ability of the wall to support heavy weights, we recommend that you add legs.

Follow the assembly instruction of your cabinet and/or frame to make sure that you are using the correct legs.

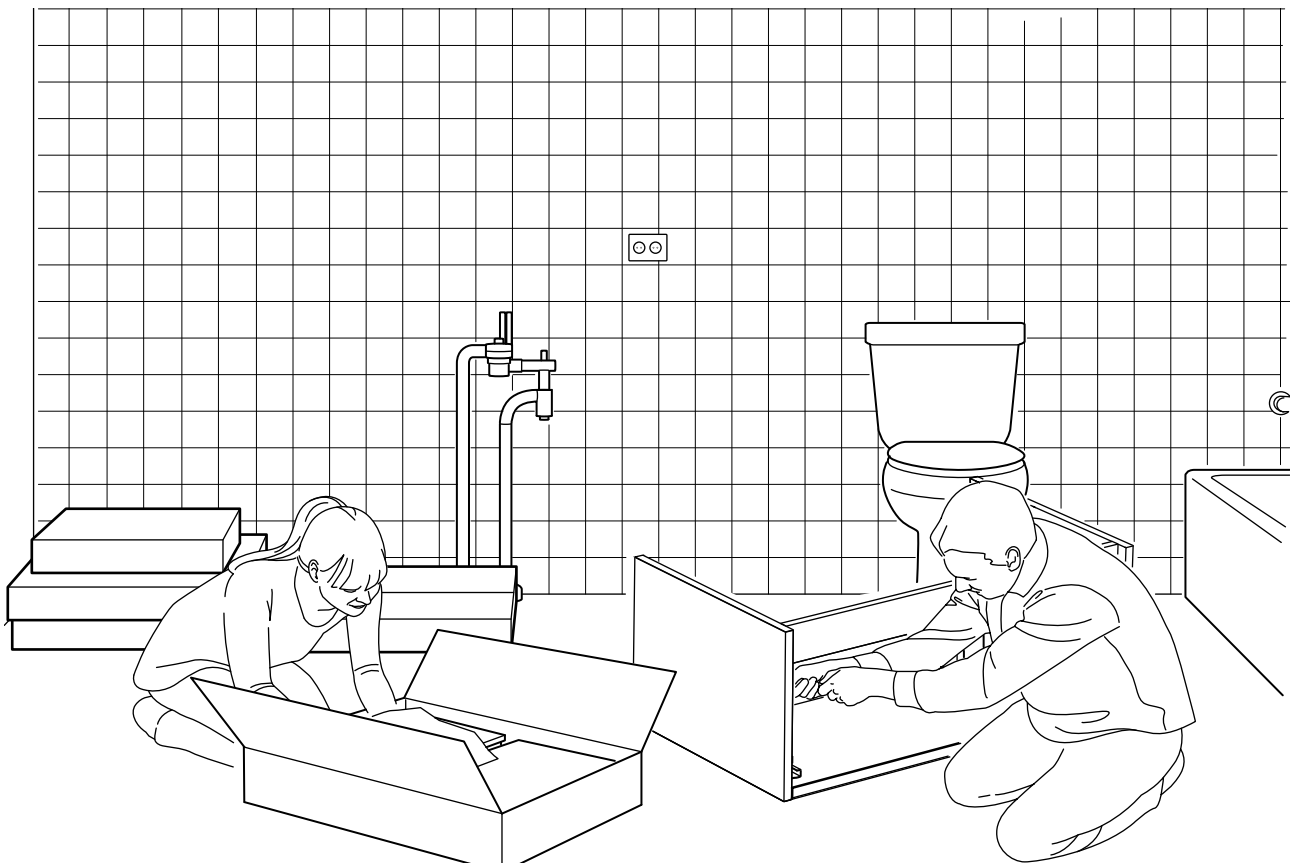

Mounting the wash-stand to the wall

You're now ready to mount your assembled furniture onto the wall. The following information is a guide that is applicable to all IKEA bathroom wash-stands and basins. However, be sure to consult the assembly instructions that came with your product for measurements that are specific to that piece of furniture. In this guide, we use HAVBÄCK bathroom products to illustrate steps that apply to all IKEA bathroom cabinets.

Measuring

The recommended height for the top level of your wash-basin is 87-92 cm. Because there are different heights of wash-basin.

Below, are 4 examples of height measurements for different types of wash-basins. Note that these measurements are intended as a recommendation only. These measurements can be changed according to your personal height preference.

Once you have established the height of your drilling points, you can concentrate on the width between them. These measurements are given in the assembly instructions of your cabinet. Use a spirit level to ensure your measurements will result in an even line. You should mark the intersecting points (height + width) with a cross (+) to give you a precise drilling point.

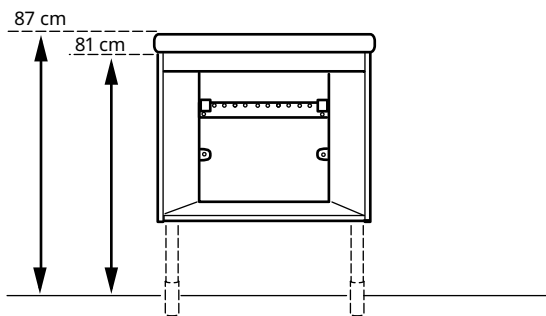

Example 1

For wash-basins with a low edge (6 cm), the holes for the fixing rail should be drilled higher (e.g. 68 cm*) to accommodate the low profile of the wash basin.

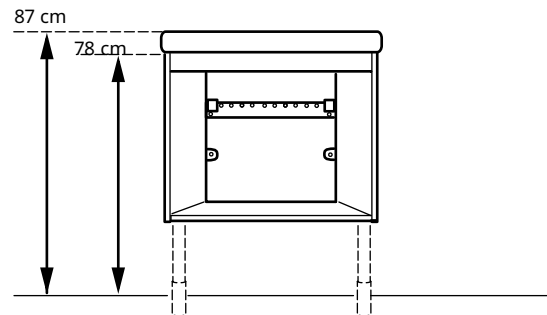

Example 2

For wash-basins with a high edge (9 cm), the holes for the fixing rail should be drilled lower (e.g. 65 cm*) to accommodate the higher profile of the wash basin.

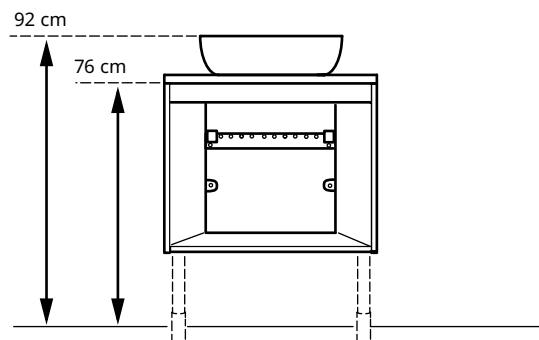

Example 3

For countertop wash-basins with a high edge (14 cm), the holes for the fixing rail should be drilled lower (e.g. 63 cm*) to accommodate the extra height of the wash-basin. The height of the top surface of the countertop should be 78 cm.

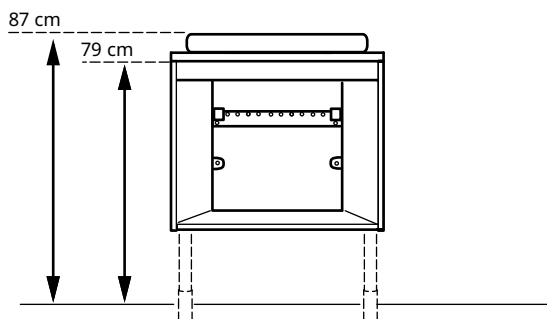

Example 4

For semi-recessed wash-basins, the holes for the fixing rail should be drilled higher (e.g. 66 cm*) to accommodate the washbasin and counter top. The height of the top surface of the countertop should be 81 cm.

*When using the top fixing holes on the furniture

Installing your bathroom

Take your time and make sure that you have a helping hand during this stage of the process. Also make sure that you have all the required tools, silicone and fixing hardware close at hand. Please note, each of our bathroom families have different fittings. But preparation is similar with drilling, leveling, etc. Always refer to the assembly instructions for your bathroom.

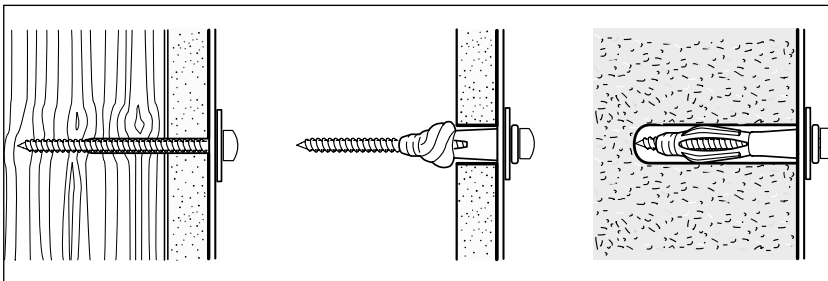
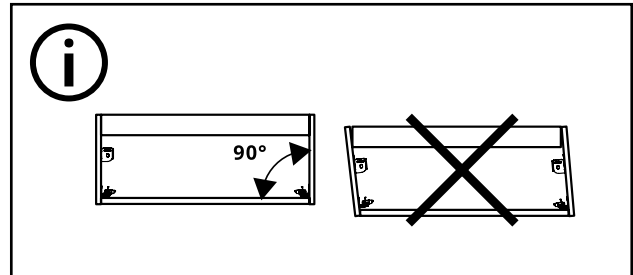

Your walls will hold the weight of your bathroom cabinets so it is critical that you check if your walls are suitable to carry the different bathroom units. Fastening devices for the wall are not included since different wall materials require different types of fastening devices. Use fastening devices suitable for the walls in your home. For advice on suitable fastening devices, contact your local specialized dealer.

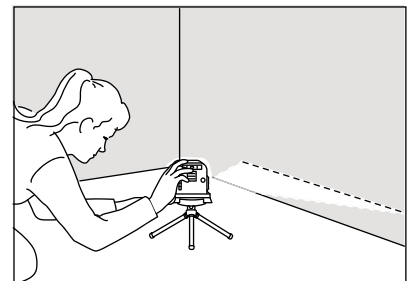

You'll need to find the highest point of the floor and mark where that is on the wall. This will be the point from which to measure the correct level work height for the bathroom furniture.

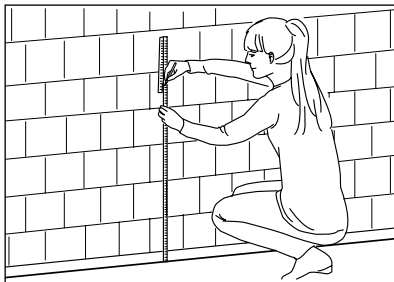

When you have decided your wash-basin height, measure from the floor up to the top of the wash-stand and draw a line (1). Then measure and draw a second line (2) where the mounting holes should be according to the assembly instruction.

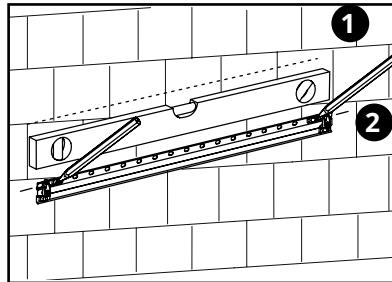

Position the rail with the upper mounting holes in level with second marked line (2) dedicated for the rail. Mark the located drilling points. See the assembly instructions.

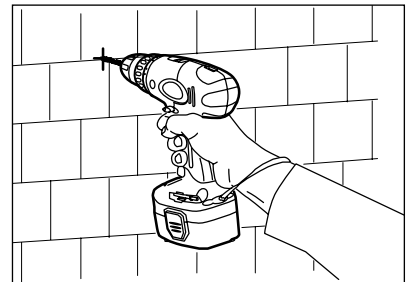

Drill the mounting holes using a diamond-tipped drill bit to avoid damage. If you haven't got one, use masking tape on the tile to prevent the drill from slipping.

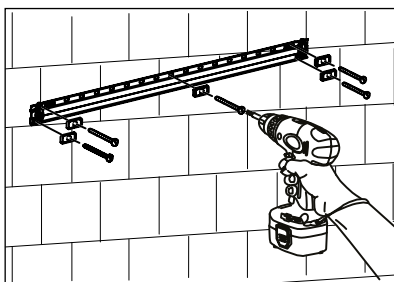

Before you fasten the screws, remember to fill the drill holes with sanitary silicone.

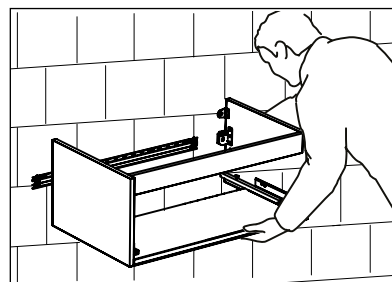

Ensure you have fixed the mounts at the rear of the wash-stand according to the assembly instructions. Then gently lift the cabinet onto the mounting screws.

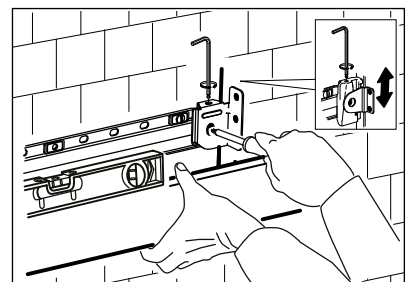

Use the spirit level again to ensure your wash-stand is even. The mounts allow some adjustment if it is not perfectly even. When the cabinet is level, tighten the screws.

Installing wash-basin, water trap and mixer tap

Before you start installing the wash-basin and mixer tap, make sure the water connections are compatible (water supply with mixer tap hoses.) Then, switch off the main water valve.

Keep in mind that installation must be performed in compliance with current local construction and plumbing regulations. If in doubt, contact a professional.

Note:

If you plan to install a wash-basin without a wash-stand underneath, see this installation option in the wash-basin assembly instruction.

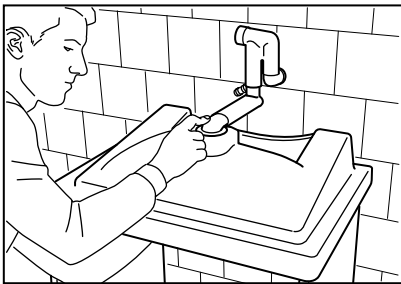

Turn the wash-basin upside down and attach the water trap according to the assembly instruction.

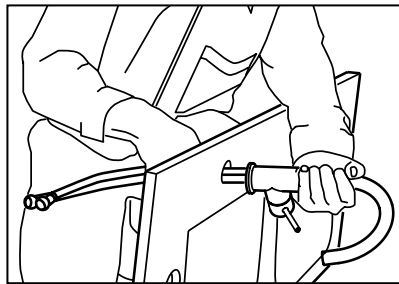

Follow the mixer tap assembly instructions to fit the mixer tap onto the wash-basin. Tighten the fixing nut/s that fit the mixer to the basin loosely, so the tap can be correctly positioned on the basin and then secured in place by fully fixing the nut/s.

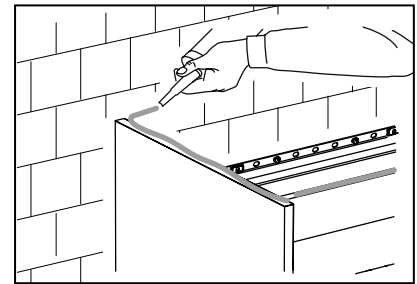

Add sanitary silicone sealant on the top edge of the wash-stand sides, front rail and the rear of the wash-basin.a

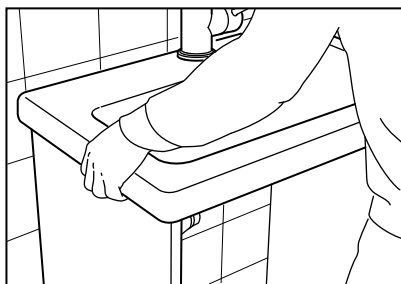

Place the wash-basin on top, remove the tape, and let dry for at least 3 hours.

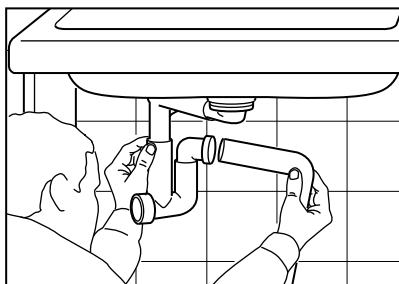

Now secure the tap position and finalize the water trap installation and connect all the mixer tap hoses according to the assembly instruction.

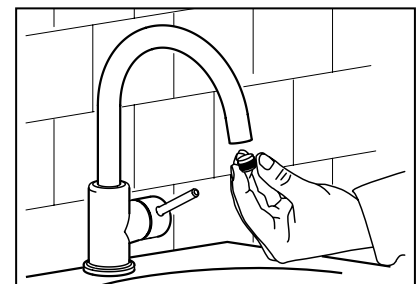

You can now turn on your main water valve. Remove areator from the water mixer and let the water run freely. Ensure there is no leakage around the hose connection and the water trap. Screw the aerator back in place. Add a bead of silicone between the wall and the wash-basin. Use tape before you apply silicone, to keep the silicone from smearing. Let dry.

Installing the bathroom wall accessories

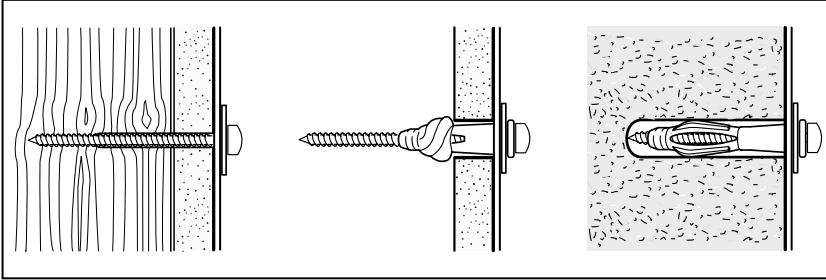

It is critical that you check if your walls are suitable to carry the weight of your bathroom units. Fastening devices for the wall are not included since different wall materials require different types of fastening devices. Use fastening devices suitable for the walls in your home. For advice on suitable fastening devices, contact your local specialised dealer.

Take your time and make sure that you have a helping hand during this stage of the process. Also make sure that you have all the required tools, silicone and fixing hardware close at hand.

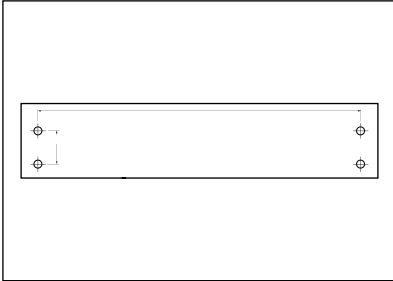

In many cases, drilling templates are provided to help mark the holes perfectly without drilling.

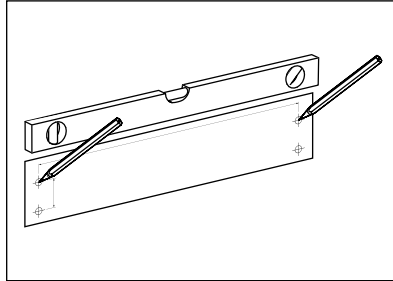

Decide where you want to install your wall-hung bathroom accessory. If the accessory has more than one anchor point, make sure at least one is anchored to a stud (if you have a stud wall, see page 6). Mark the drilling points. Use a spirit level to ensure the points are level. Follow the assembly instructions that come with each product.

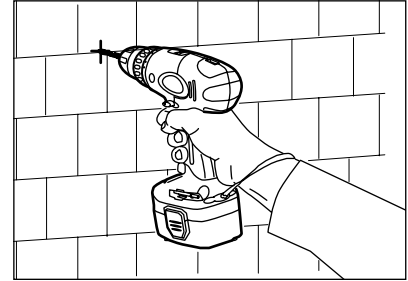

For tiles: Drill the mounting holes using a diamond-tipped drill bit to avoid damage. If you haven't got one, use masking tape on the tile to prevent the drill from slipping. Before you fasten the screws, remember to fill the drill holes with sanitary silicone.

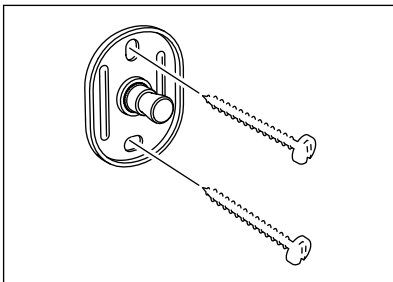

Now you are ready to attach the product to the wall. Follow the assembly instructions that come with each product.

Drilling into tiles

Tiles in bathrooms are both functional and beautiful, but many feel cautious about drilling into tiles to install wall accessories like shelves, mirrors and hooks. With careful preparation and the right tools, there shouldn't be a problem. Whether you already have tiles on your walls or plan to put up new tiles, we have some tips and advice to help you along the way.

Important to plan

Planning is essential when drilling into tiles, partly to make the installation symmetric, but also because there are certain rules for drilling in wet rooms. Therefore, measure carefully, where to locate the holes. Try to position them so that you drill into the tile joint. It is easier and enables you to re-joint a hole if you remove or replace your accessory. A hole directly in the tile, is difficult to hide and the porous material risks cracking when exposed to great pressure.

There are also certain rules for drilling holes in tiles in wet rooms. In case of the slightest uncertainty, we recommend that you contact a qualified installer for advice before starting drilling. Feel free to also contact your insurance company for information about what applies in the event of a payment if a private individual has drilled in a wet room. If everything is in order, you can now move on to how to drill in tiles.

When drilling into tiles, there is a risk of chipping. Therefore, put on a pair of suitable safety glasses.

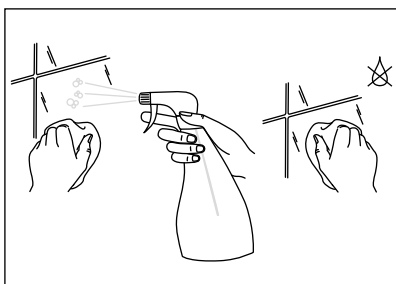
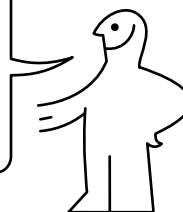

Start by cleaning the tile with a damp cloth and check if it has any cracks. If it has a crack, do not drill into it.

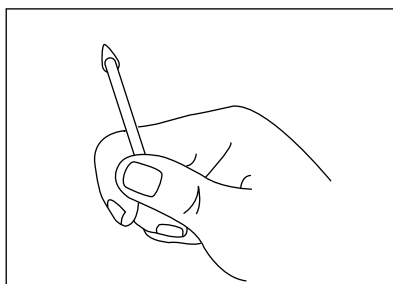

To drill into tiles, you need a special drill bit for ceramic tiles that won't cause cracks. You can use the tile drill bit together with your regular drill. Do not use an impact driver.

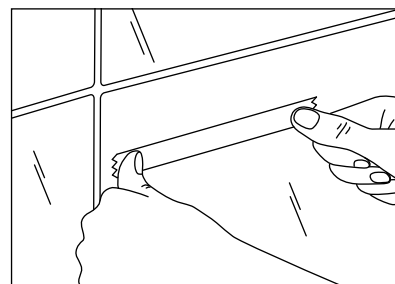

Using masking tape, mark the point where you are going to drill with an X. The tape will reduce the risk of slipping with the drill, especially if you are in an uncomfortable working position. Keep in mind that you must be able to see the mark under the tape.

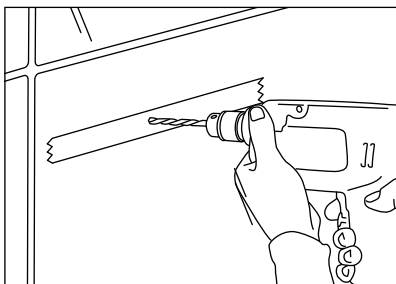

Time to drill! Drill slowly at low speed and apply modest pressure to avoid the tile cracking. The friction may cause the drill bit to overheat, which can damage the tile. Have a spray bottle with water nearby and spray the tip of the bit about every 15-20 seconds. Take a break if you notice that the bit is still getting very hot.

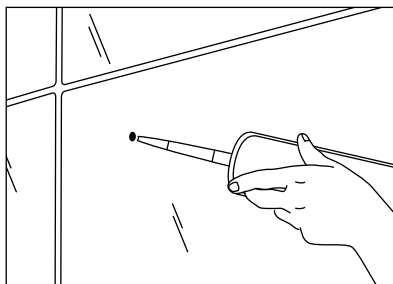

Carefully pull out the drill and remove any drill dust. Fill the hole with wet room silicone and insert screws or plugs

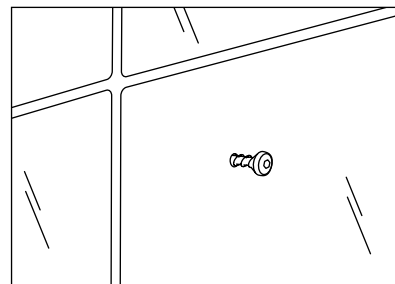

There you go! Now you're ready to put up your bathroom wall accessories.

Drill-free accessories for wall mount

Before you install your drill-free accessory, make sure you have a suitable wall surface, such as glass, mirrors and tiles. Do not attach adhesive products to wallpaper or plastic surfaces as this can damage the material.

Always follow the assembly instructions that come with each product.

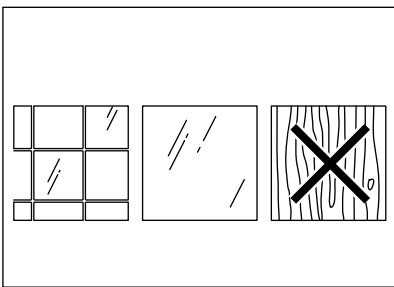
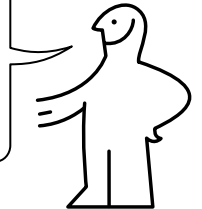

Make sure you have a suitable surface for your drill-free accessory. Suction cups and adhesives will only stick on smooth surfaces like glass, mirrors and tiles.

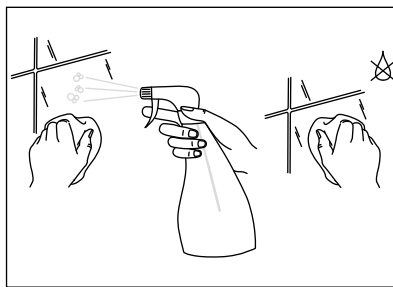

Before you mount the accessory, wipe the surface clean with a cloth dampened with a mild cleaner. Wipe it dry with a clean cloth. This will ensure a better grip. Follow the care instructions that comes with the product.

Suction cup solutions

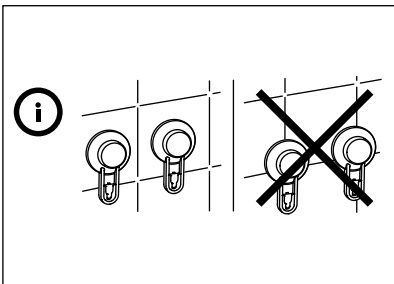

Do not mount the suction cups over joints as this will weaken the hold.

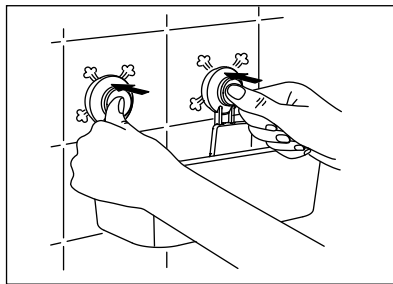

After cleaning and drying, follow the assembly instructions that comes with the product.

Adhesive solutions

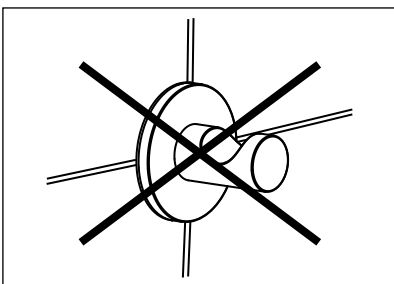

Do not mount the adhesive over joints as this will weaken the hold.

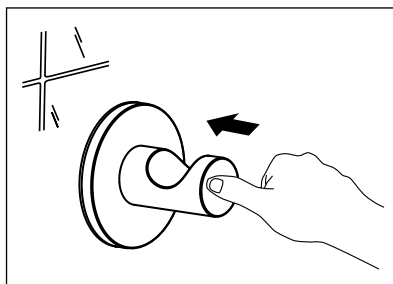

After cleaning and drying, follow the assembly instructions that comes with the product.

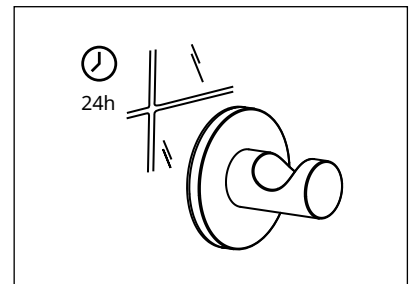

Follow the recommended drying time before you use the product to ensure a good hold.

The finishing touches make all the difference

Your dream bathroom starts with thorough planning. From considering you and your family's activities and needs, to preparing the room and installing your bathroom furniture. But to complete your solution you may want to personalise it by making it even more functional and coordinated.

IKEA offers a wide range of colourful bath textiles, bathroom accessories and lighting for every taste and style. Textiles help you complete your dream bathroom by adding softness and beauty that suit you and your family.



Services

Our broad service offer gives you the freedom to decide how much you want to do yourself and how much you want us to do for you.

Below you'll find all the services that we can offer.



Measuring

If you want to be sure that your room drawing is as accurate as possible, we measure the room and check everything, from the placement of windows, doors and power sockets to the material and condition of the walls.



Planning

Get help with the planning of your new bathroom by visiting one of our stores or plan and order points. You bring the measurements and drawing or a picture of the area – we help you with inspiration and functional solutions for everything, from the placement of cabinets and appliances, desks and storage to lighting, sinks and wash-basins.



Delivery

Whether you're shopping in store or online, and no matter how big the purchase, we'll do the heavy lifting and bring it to your home or business. We deliver on a day and at a time that suits you.



Removal

When you buy a bathroom with delivery from us we're happy to take care of your old one. Whatever can't be used will be recycled responsibly.



Bathroom installation

If you want to make things smooth and easy for yourself – our installation partner [NeedHelp.com](#), will install your new bathroom and coordinate the job from start to finish. They handle all those time-consuming jobs like fitting wash-basin and mixer tap and you can rest assured that the electric installation of your lighting fixtures is done properly. They also take the packaging with them when your bathroom is in place.



Payment options

We accept many payment methods, including cards and cash. And if you need a little longer to settle your bill, we can help you spread the cost with our Financing services.

